

Shelf LED Display

The LED shelf display is a slim LED advertising screen designed for impactful and creative visual marketing. You can upload content via USB, Wi-Fi, 4G, or a network connection. Additionally, you can connect multiple shelf LED screen to create a larger display or divide the screens to play multiple video product promotions.

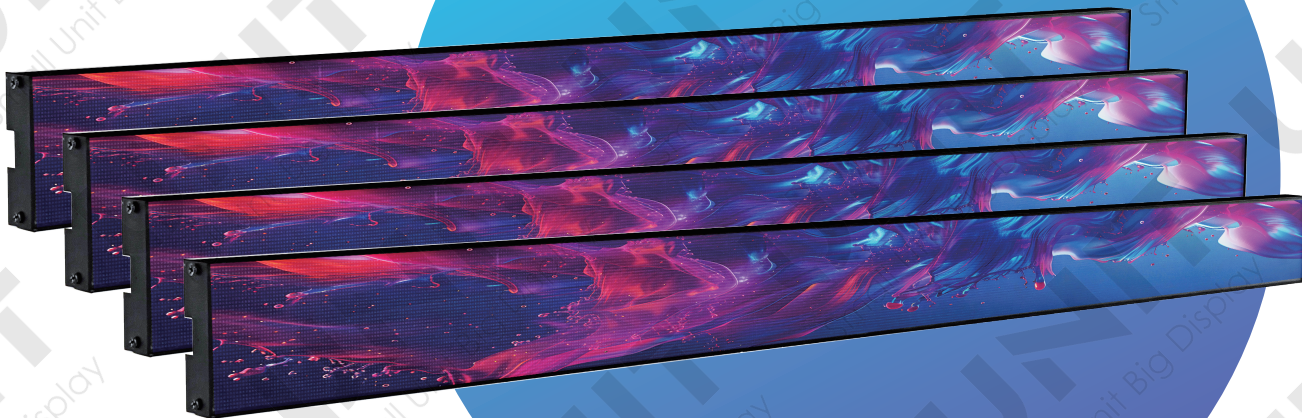

Shelf LED Display Introduction

LED Module

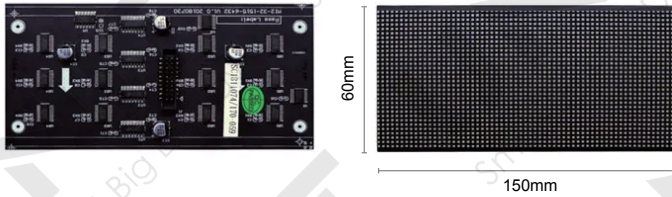

The shelf led display module is made with GOB craft to offer an excellent visual experience. 150X60mm, 300x120mm, 200x50mm, 200x150, 200x100mm, 128x128mm, 128x64mm are available.

Size

Shelf LED Display (W×H×D):
With frame: 303 × 64 × 21 mm
Display area: 300 × 60 × 21 mm
(Refer to the front and rear views for the 300 mm length.)

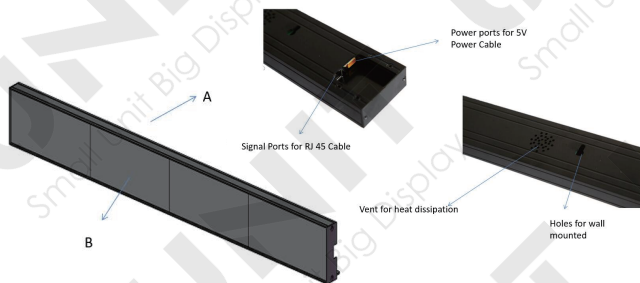
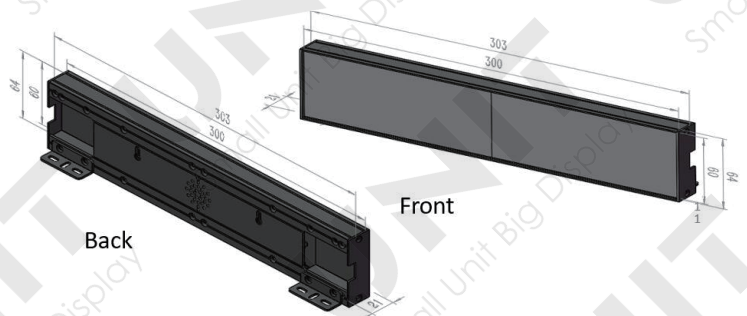

Product Makeup

A: Aluminum Alloy Frame: Constructed from a single straight frame connected to an aluminum plate on the side, ensuring perfect flatness in the display.
B: GOB Technology on Modules: Provides enhanced protection against touch, impact, and water spray.

GOB Technology, High Protection Capability

The TOP-GOB process applies a surface coating, fully sealing the PCB board with epoxy resin. This enhances protection against physical damage and provides features such as anti-fog, dust-proofing, ease of cleaning, abrasion resistance, damp-proofing, anti-collision, antistatic properties, oil pollution resistance, and anti-oxidation.



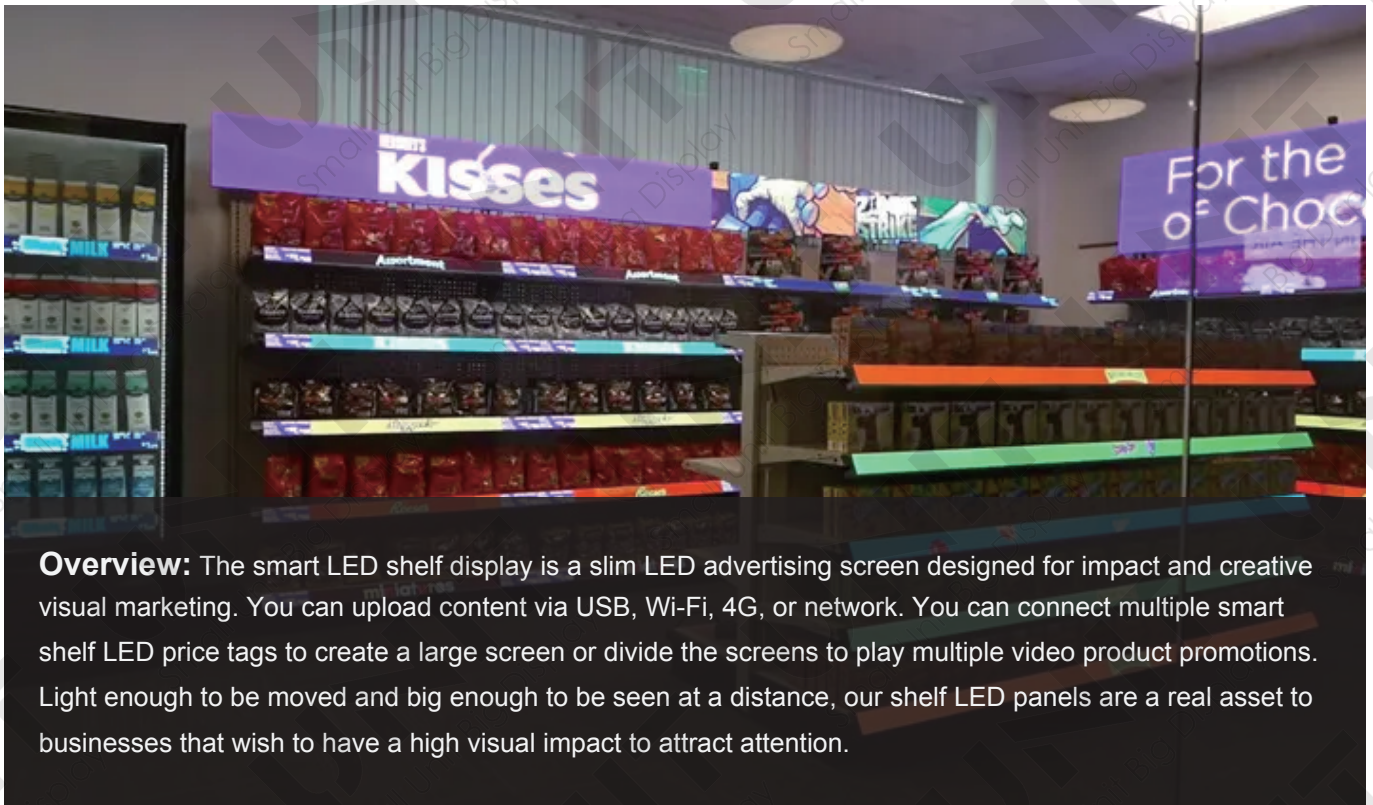

Overview: The smart LED shelf display is a slim LED advertising screen designed for impact and creative visual marketing. You can upload content via USB, Wi-Fi, 4G, or network. You can connect multiple smart shelf LED price tags to create a large screen or divide the screens to play multiple video product promotions. Light enough to be moved and big enough to be seen at a distance, our shelf LED panels are a real asset to businesses that wish to have a high visual impact to attract attention.

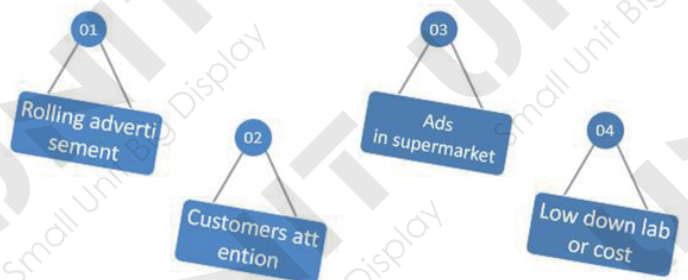
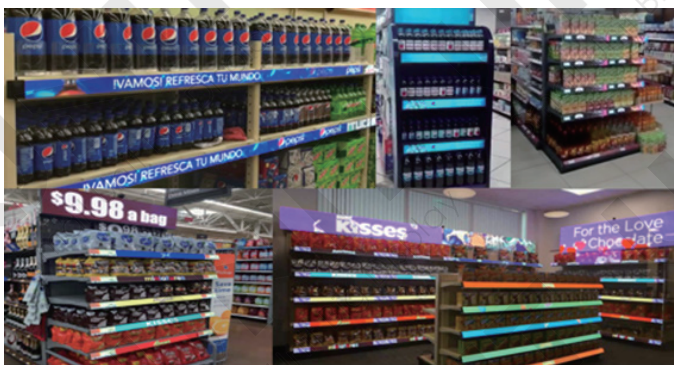

Features

- Super slim in depth and light in weight.
- 22mm thickness ,thickest in the whole market, easy to install and move.
- Multiple installation modes, such as stand, wall-mounted and etc.
- Plug-in display, simple operation.
- Multiple linkage modes, such as single display application, cascaded application and creative application, etc.
- USB/ Wi-Fi/ HDMI / cable connection; mobile phone & PC quick management & publish.
- LAN integrated publish & remote publish via internet.
- Calibration data saved on modules, recover factory settings in 5s.

High Quality With Global Standards,
CE EMC, RoHs, FCC Certificated.

Specification

	Pixel Pitch (mm)	P1.2mm	P1.5mm	P1.875mm	P1.5625mm	P2mm
Optical Parameter	Viewing Angle (H/V)	160° / 160°	160° / 160°	160° / 160°	160° / 160°	160° / 160°
	Brightness (cd/sq.m.)	800	800	800	800	800
	Refresh Rate (Hz)	>3840	>3840	>3840	>3840	>3840
	Optimized Viewing Distance (m)	1~10	1~10	1~10	1~10	1~10
Electrica Parameterl	Input Voltage	AC110V or AC220V±10%50/60Hz				
	Input Interface	Ethernet / USB / Wi-Fi				
Structure Parameter	Module Size in Pixel (W×H)	125×50	100×40	80×32	128×32	64×32
	Module Size in mm (W×H)	150x60mm/300x120mm				
	IP Rating	IP 40				
	Maintenance	Rear				
Optical Parameter	Operating Temperature/Humidity (C/RH)	-10 C ~40 C/10~90RH%				
	Certification	CCC / CE / ETL / FCC				